

ELECTRICAL TEST WORKSHOP MANUAL

CONTENTS

- 1. ELECTRICAL TESTS 5**
- The test apparatus: 5
- Wires: 7
- Resistances: 7
- Bulbs: 8
- Saddle control: 8
- Magneto: 9
- Ignition: 13
- ignition coil: 13
- Battery: 14
- Lighting transformer: 15
- Voltage regulator: 15
- Switches: 16
- Oil level low sensor: 16
- Fuel gauge: 17
- Starter motor relay: 17
- Diodes: 19
- Red diodes (LEDs) 19
- Miscellaneous 20

1. ELECTRICAL TESTS

The test apparatus:

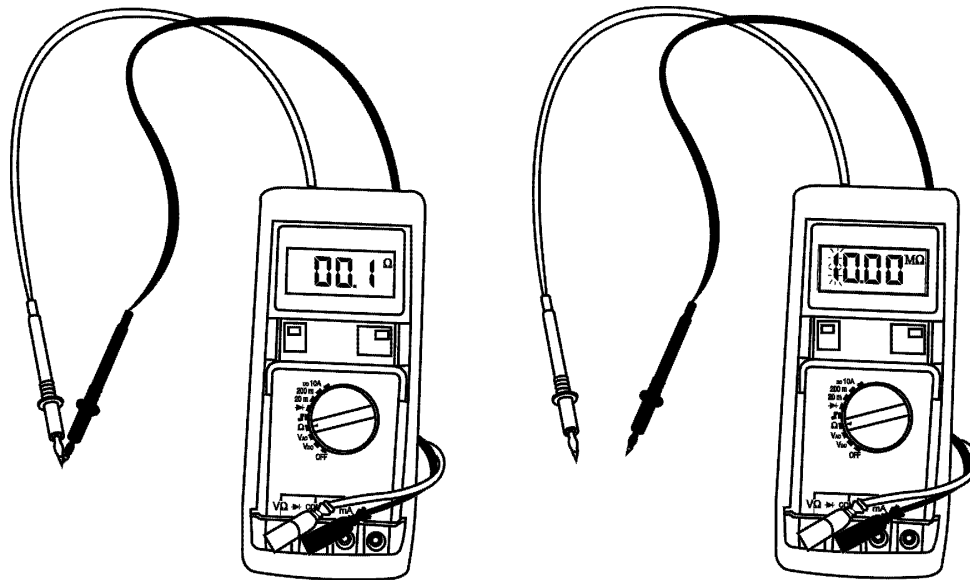

For the electrical tests, a multimeter must be used. This apparatus is used to test values, resistances, voltages, currents, etc...

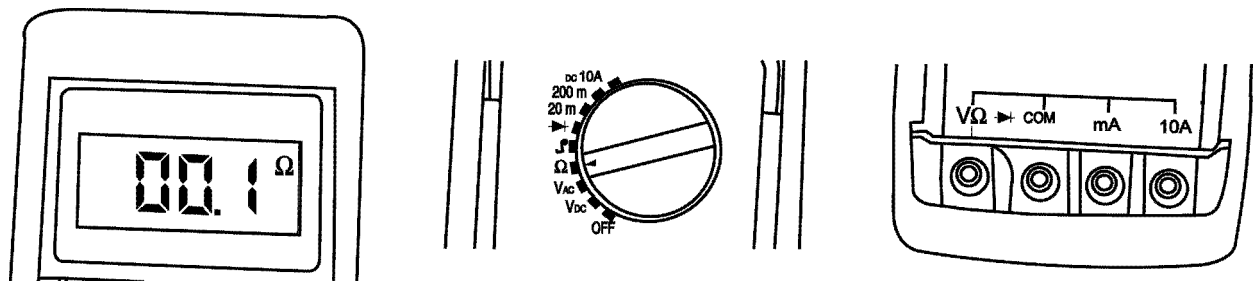

Before using this apparatus, carefully read the instructions supplied with it. Generally speaking, the multimeter has a display window, a rotary knob for selecting the type of measurement and range, and a set of sockets to select the ammeter range.

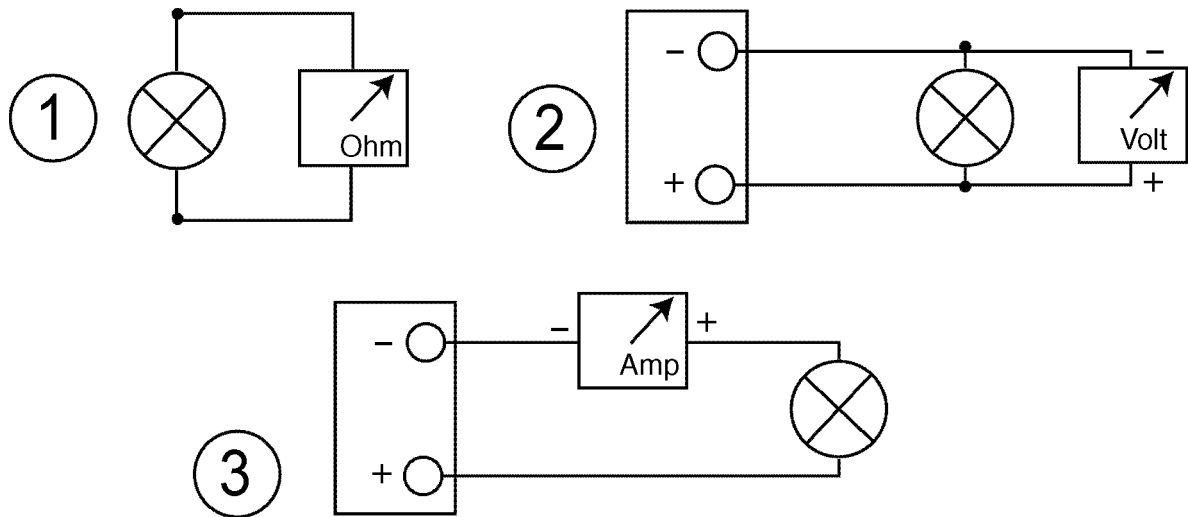

Reminder:

1. For measuring resistances, the item being measured must be disconnected from the circuit.
2. For measuring voltage, the machine battery must be connected, the ignition on and the multimeter connected in parallel with the equipment being tested.
3. For measuring current, the machine battery must be connected, the ignition on and the multimeter connected in series with the equipment being tested.

Special cases:

Used as an ohmmeter:

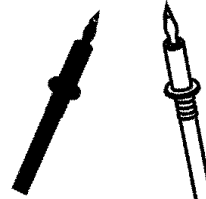

1. When the two wires of the multimeter are in contact, the ohmmeter shows a value of between 00.0 Ω and 00.5 Ω representing zero resistance. If it does not, change the multimeter battery.
2. When the two wires are separated, the ohmmeter shows by a special display (either 10.00 $M\Omega$ with the 1 which flashes, or ----) that there is no connection. This represents an infinite resistance. (see apparatus instructions)

Note: the ohm values of the coils are given for information and may vary from one multimeter to another.

Wires:

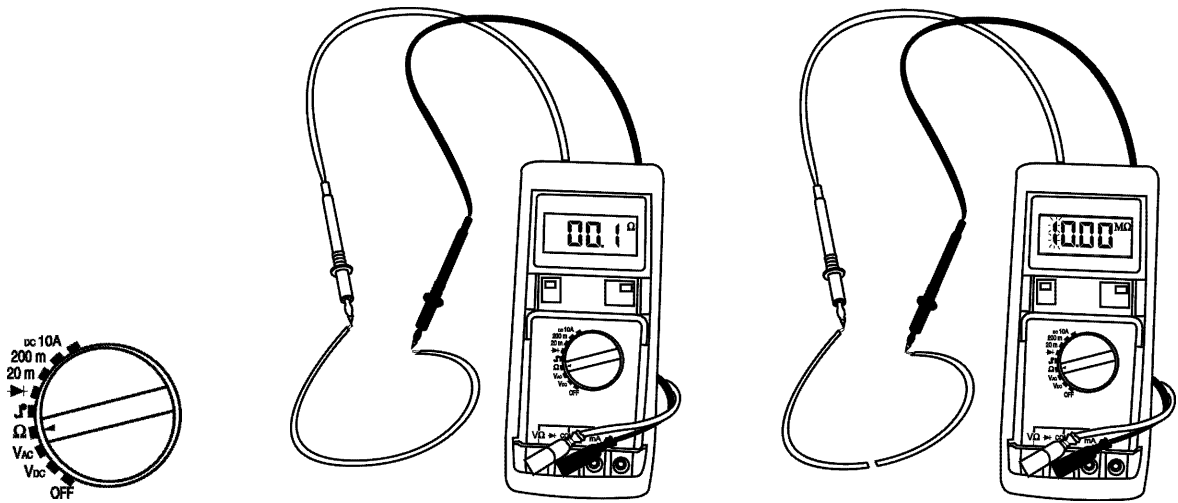

Wire intact	00.1 Ω to 00.5 Ω
Wire cut	Infinity

Resistances:

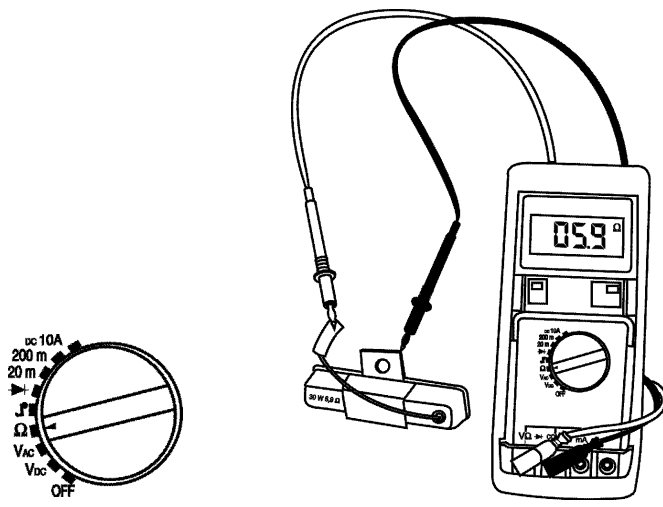

Choke limitation resistance (6.7 Ω 5W)	5.3 to 8 Ω
Lighting resistance (5.9 Ω 30W)	4.7 to 7 Ω

Bulbs:

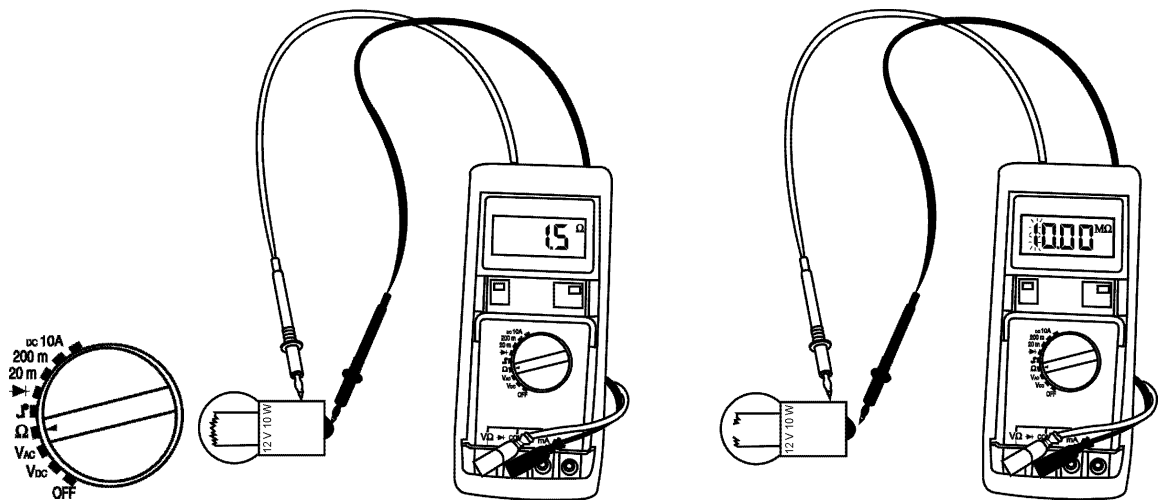

Bulb 12V 1.2W	12 Ω ±25%
Bulb 12V 5W	2.8 Ω ±25%
Bulb 12V 10W	1.4 Ω ±25%
Bulb 12V 15W	0.9 Ω ±25%
Bulb 12V 35W	0.4 Ω ±25%
Bulb blown	Infinity

Saddle control:

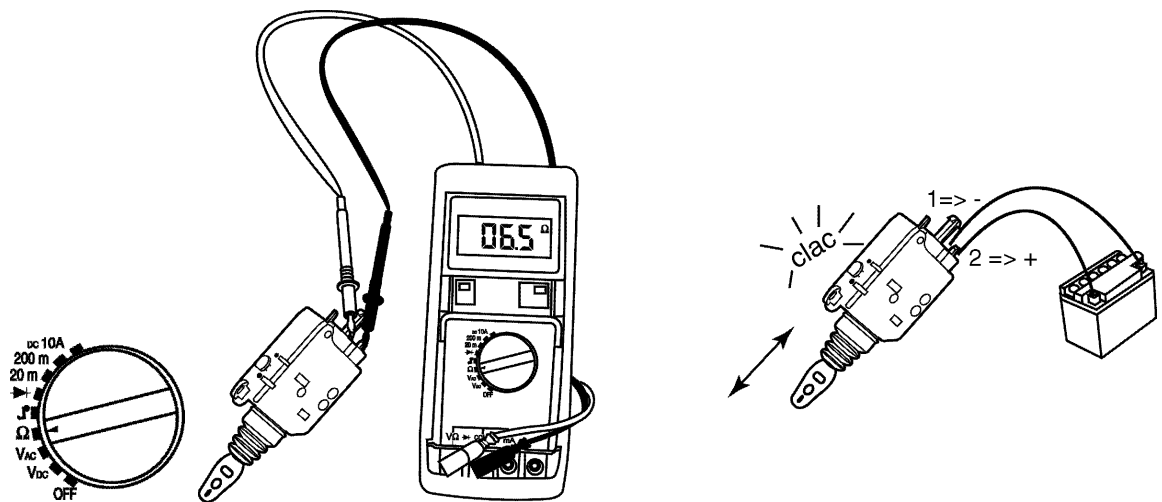

Between terminals 1 and 2 note that the probe connections determine the direction of movement	10 Ω to 40 Ω
---	--------------

Magneto:

Single-phase:

Reminder:

Moped and Fox (ignition coils, lighting coils, accessory coils)
Moped 4-pole magneto (ignition coils, lighting coils, accessory coils)
Fox with battery (ignition coils, lighting coils, battery charge coils)
CDI ignition (ignition coils, lighting coils, battery charge coils)
AEC 400 ignition (ignition coils, lighting coils, battery charge coils)
AC ignition (lighting coils, battery charge coils)

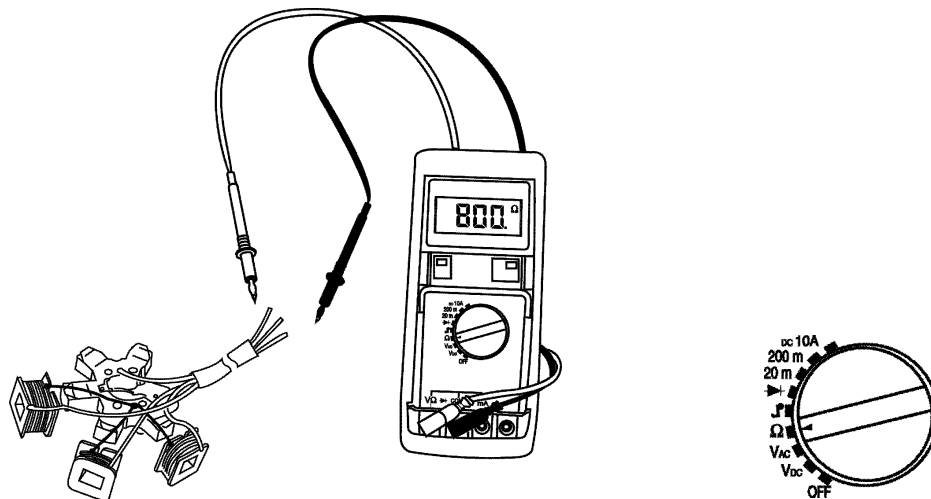

Mopeds and Fox

Ignition coil between red/black wire and earth	0.800 KΩ ±20%
Lighting coil between yellow wire and earth	0.9 Ω ±20%
Ignition sensor between yellow/blue wire and earth	106 Ω ±15%

Additional 6W coil	2.1 Ω ±20%
Additional 10W coil	3.5 Ω ±20%
Additional 15W coil	5.25 Ω ±20%

4-pole magneto mopeds:

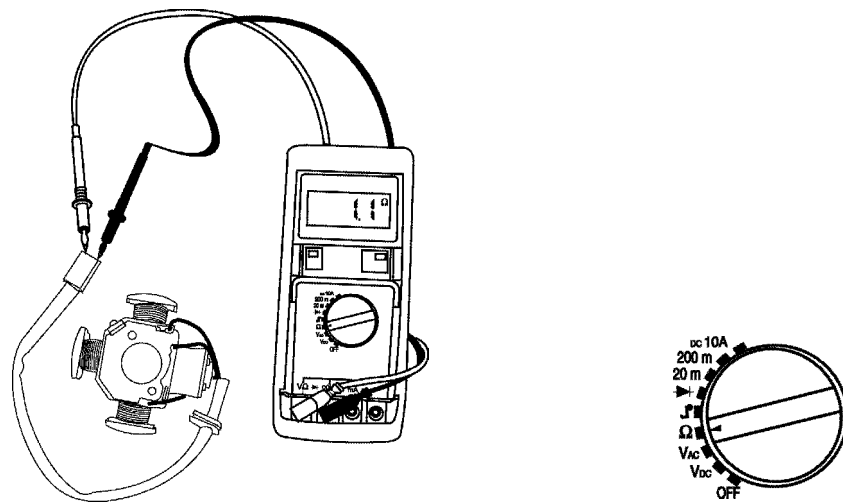

Ignition coil between red/black wire and green wire	0.800 K Ω \pm 20%
Lighting and accessories coil between yellow wire and green wire	1.1 Ω \pm 20%

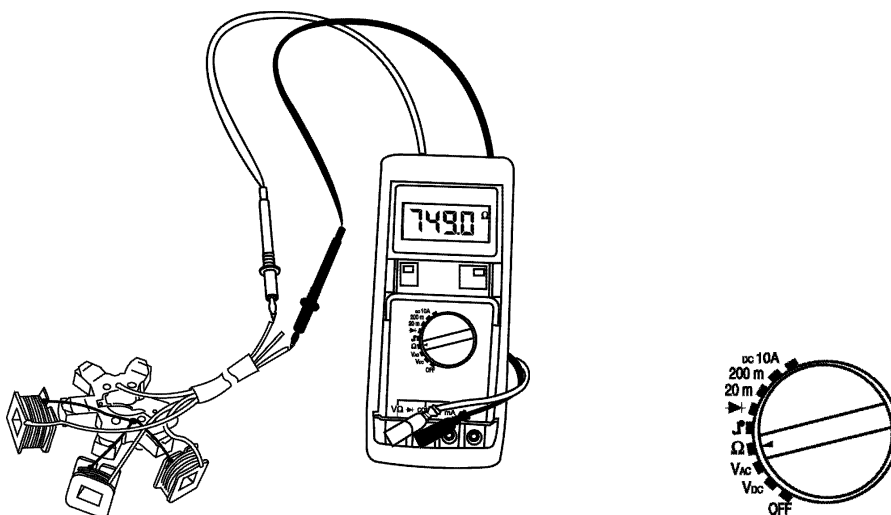

Fox with battery

Ignition coil between red/black wire and earth	0.745 K Ω \pm 20%
Lighting coil between yellow wire and earth	0.9 Ω \pm 20%
Battery charge coil between white wire and earth	1.1 Ω \pm 20%
Ignition sensor between yellow/blue wire and earth	106 Ω \pm 15%

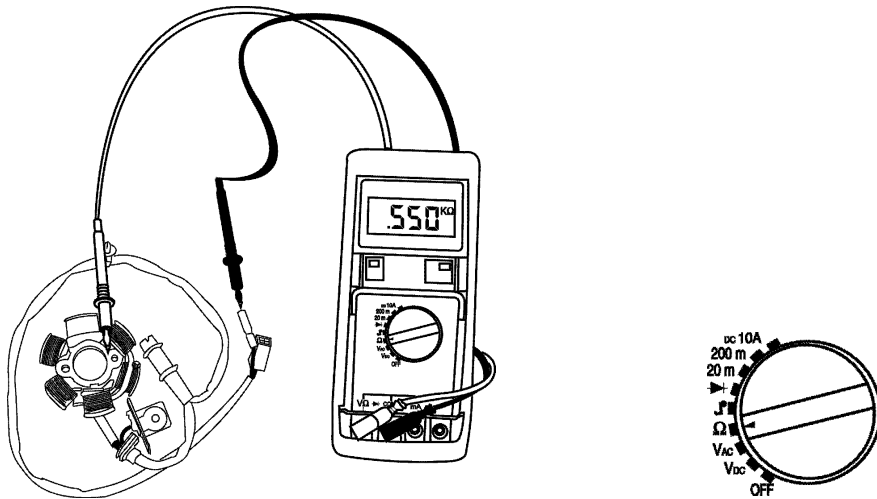

50cc and 100cc scooters with CDI and AEC 400

Ignition coil between red/black wire and earth	0.550 KΩ ±20%
Lighting coil between yellow wire and earth	0.6 Ω ±20%
Battery charge coil between white wire and earth	0.8 Ω ±20%
Ignition sensor between yellow/blue wire and earth	120 Ω ±15%

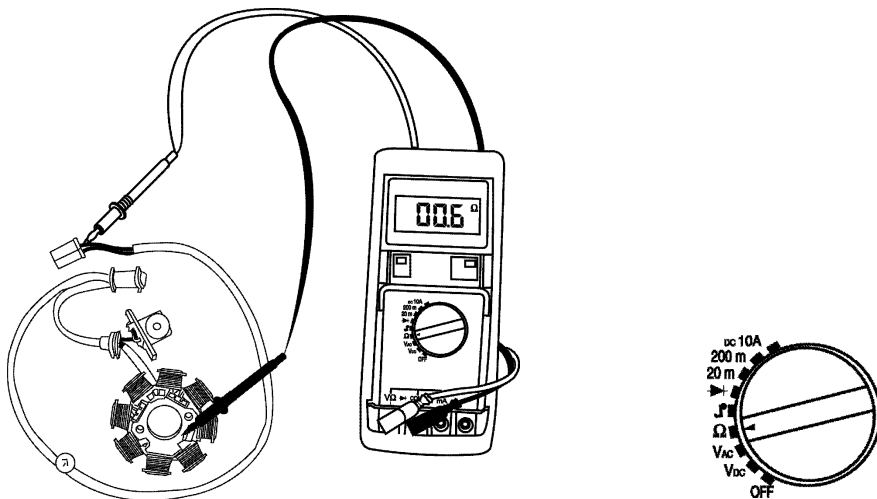

50cc and 100c scooter AC1100

Lighting coil between yellow wire and earth	0.6 Ω ±20%
Battery charge coil between white wire and earth	0.8 Ω ±20%
Ignition sensor between yellow/blue wire and earth	120 Ω ±15%

Triphase:

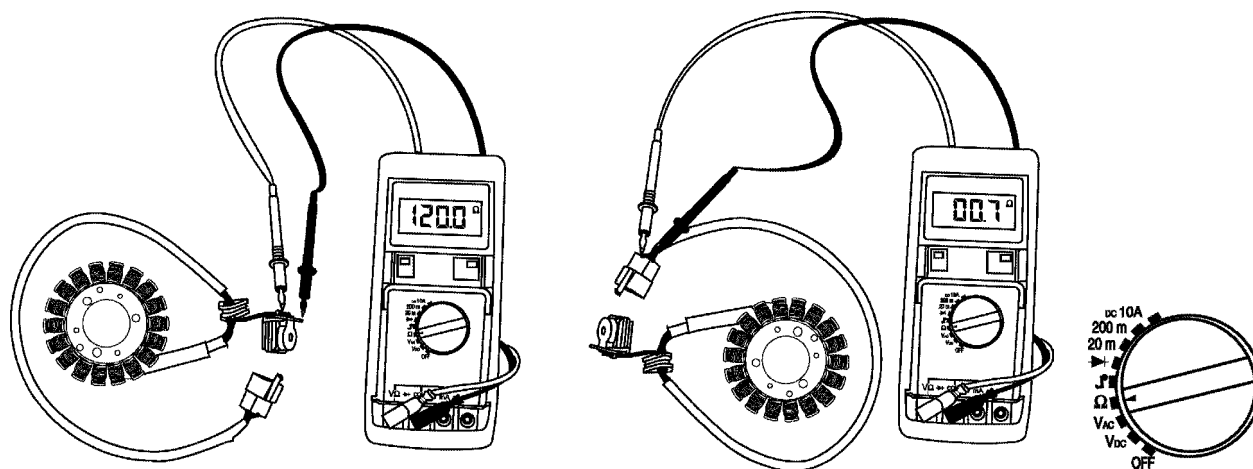

125cc and 150cc scooters

Circuit power coil between each of the 3 yellow wires	0.5 Ω ±20%
Ignition sensor between yellow/blue wire and earth	120 Ω ±15%

Ignition:

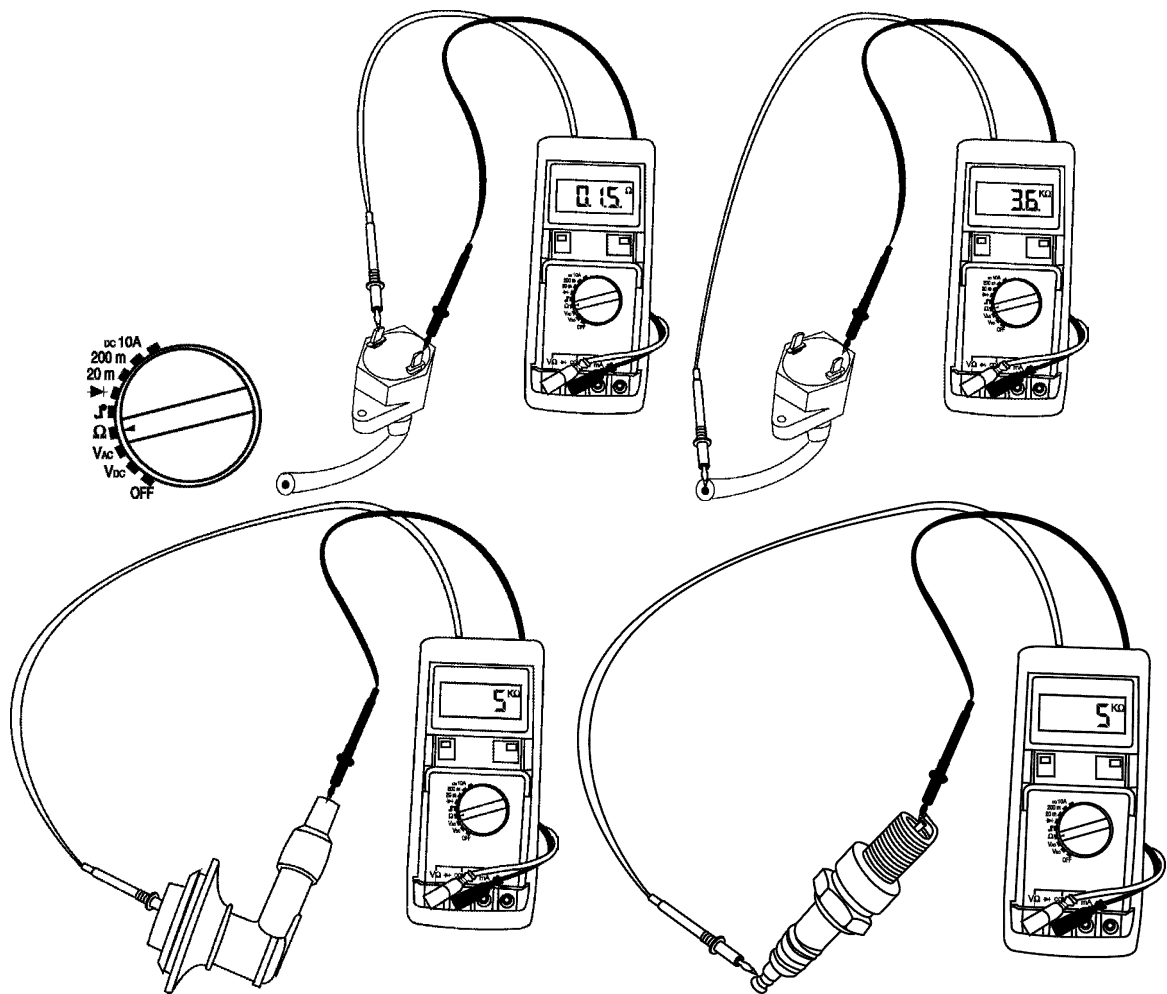

Coil primary between black terminal and green terminal	0.15 to 0.25 Ω
Coil secondary between green terminal and HV	3.6 to 4.5 KΩ
Spark plug suppressor	5 KΩ ±10%
Resistor spark plug	5 KΩ ±25%

ignition coil:

CDI module	Not testable
AEC 400 module	Not testable
ACI 100 module	Not testable

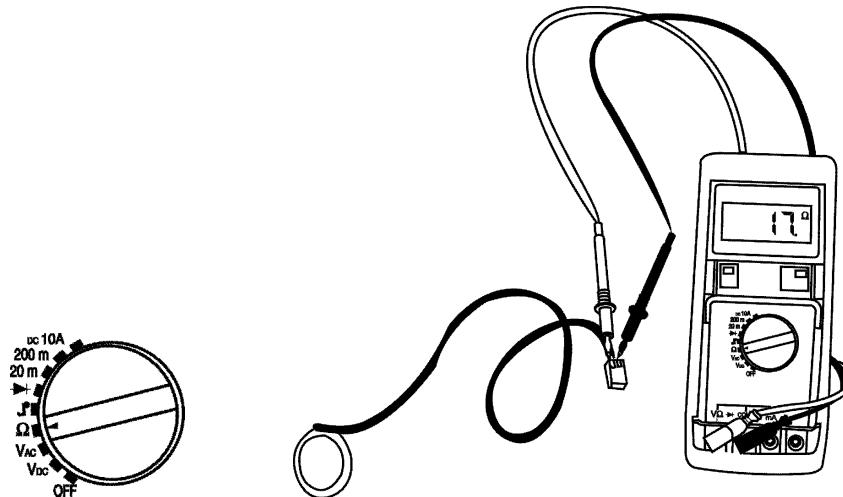

Transponder antenna	17 Ω ±20%
---------------------	-----------

Battery:

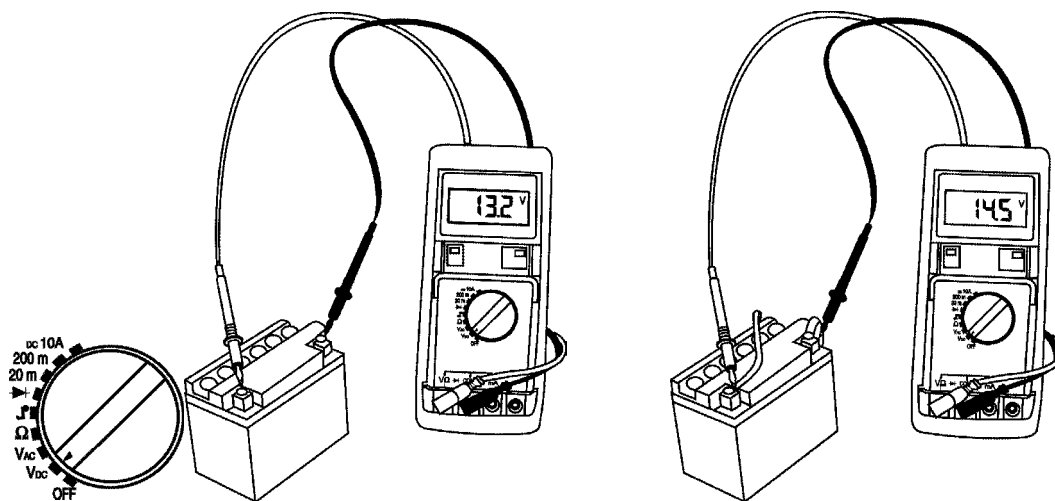

No load, battery charged	12.5 V to 13.5 V
Charging voltage, engine running	14 to 15 V
Battery flat but in working order	12 V
Battery unserviceable	<10 V
Charging current (depending on type of magneto and battery voltage)	0.1A to 20A

Lighting transformer:

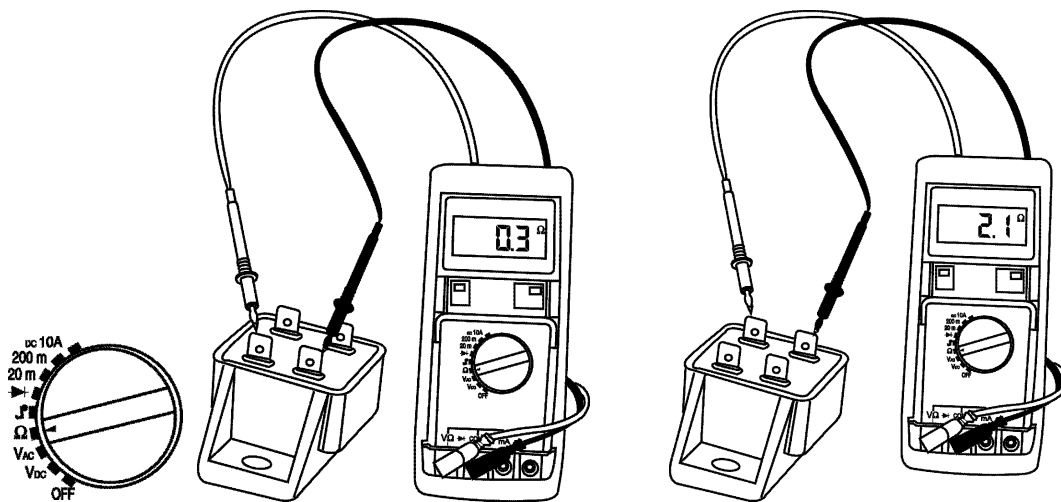

	Primary	Secondary
Isolating transformer M (6W)	1.2 Ω ±10%	2.1 Ω ±10%
Isolating transformer H (6W)	1.2 Ω ±10%	2.7 Ω ±10%
Isolating transformer G (15W)	0.4 Ω ±10%	2.8 Ω ±10%
Isolating transformer S (15W)	0.3 Ω ±10%	2.1 Ω ±10%

Voltage regulator:

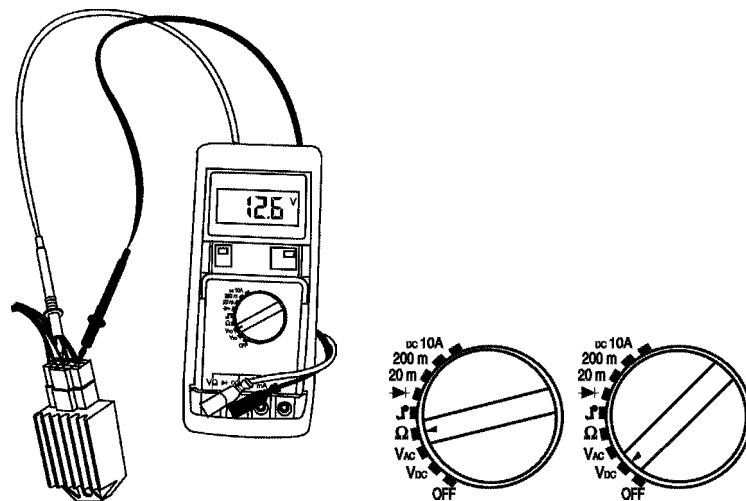

Engine stopped battery disconnected

Resistance between green wire and battery “-“	00.1Ω to 00.5 Ω max
---	---------------------

Engine running:

Direct current between red and green wires	14 to 15 V
alternative current between yellow and green wires	12.6 to 13.6 V

Switches:

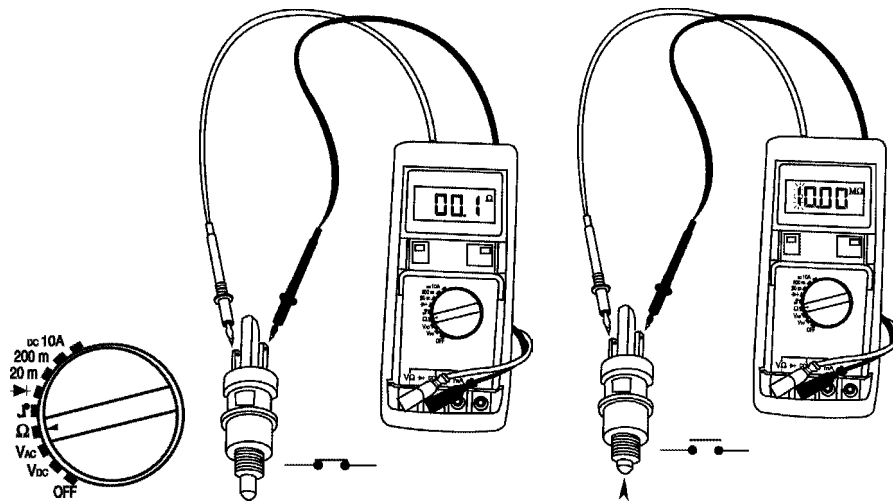

Switch closed	00.1 Ω to 00.5 Ω
Switch open	Infinity

Oil level low sensor:

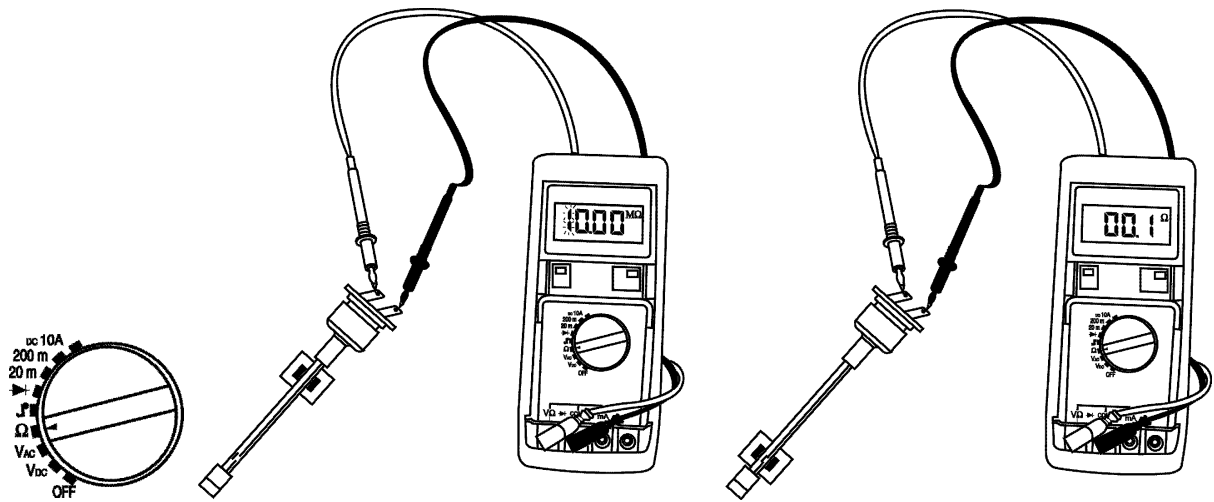

Switch open tank full	Infinity
Switch closed tank empty	00.1 Ω to 00.5 Ω

Fuel gauge:

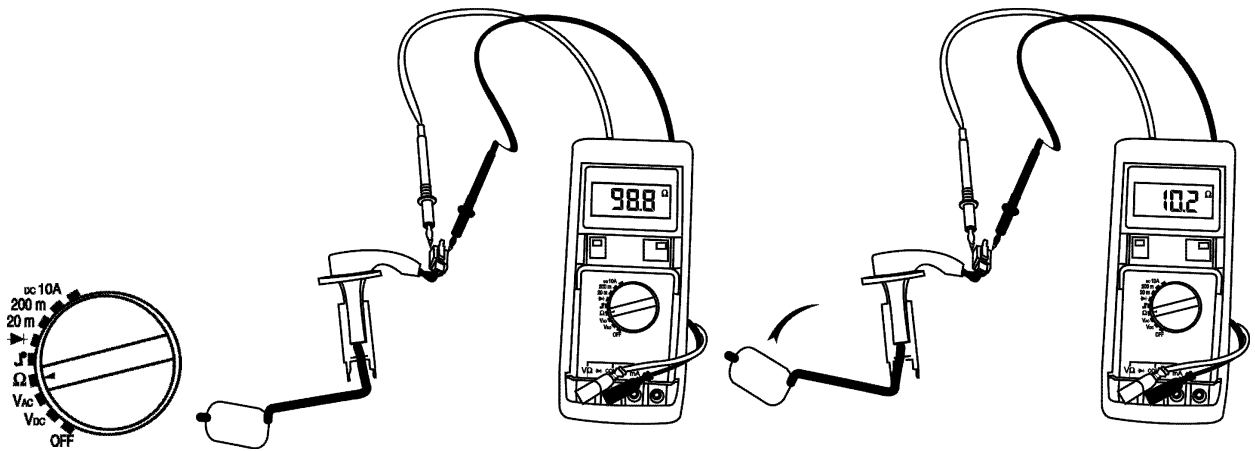

Tank empty	90 Ω to 120 Ω
Tank full	0 Ω to 12 Ω

Starter motor relay:

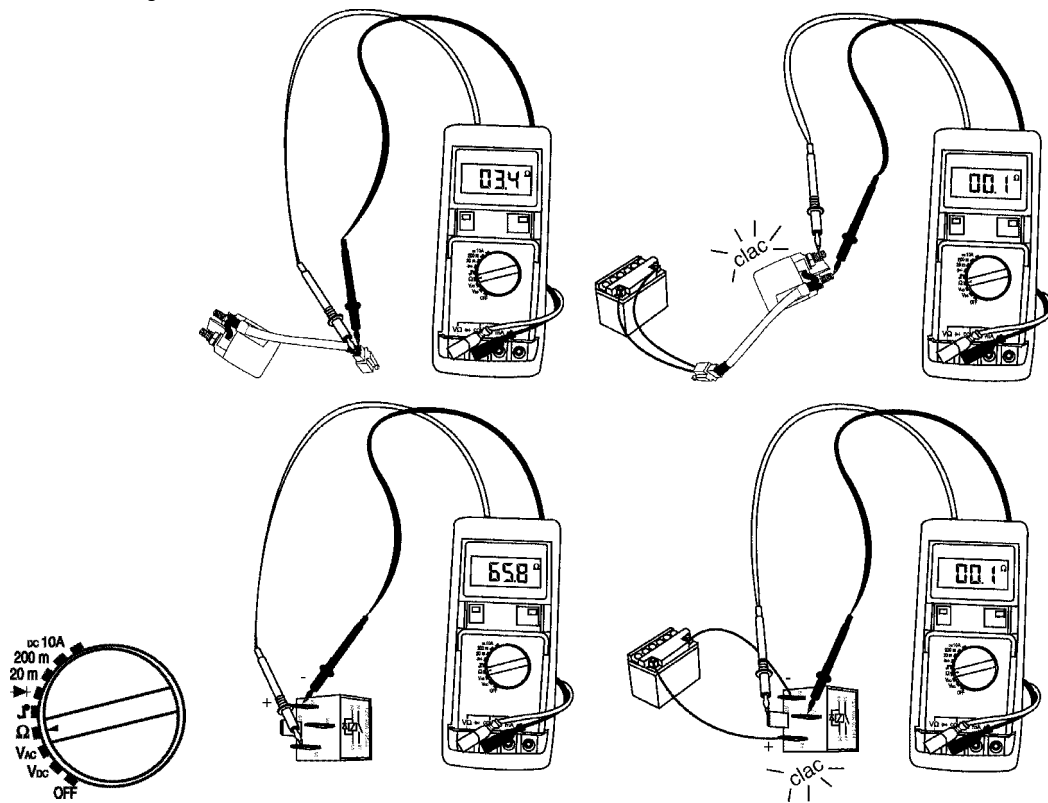

Large relay (125cc) primary	3.4 Ω
Small diode type electronic relay, primary, ensure connections made the right way round	65.8 Ω

Relay powered, secondary	00.1 Ω to 00.5 Ω
--------------------------	--------------------------------

Diodes:

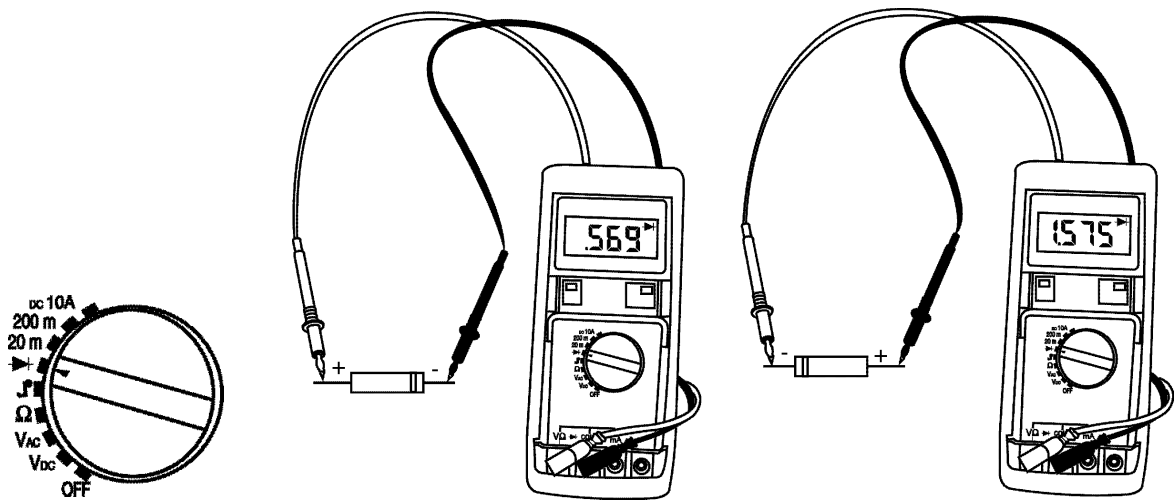

Flow direction	Reading under 1 Ω
Opposite direction	Reading over 1 Ω

Red diodes (LEDs)

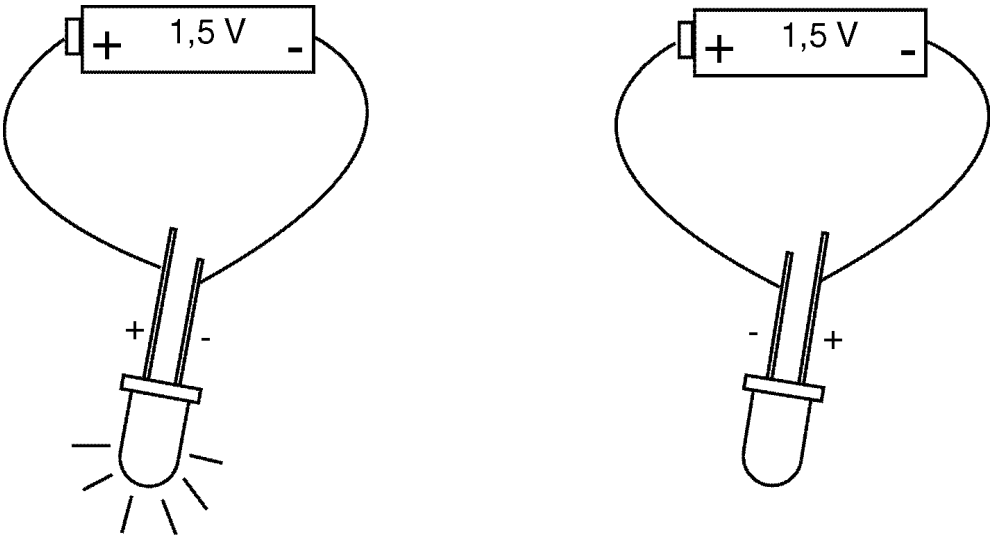

Miscellaneous

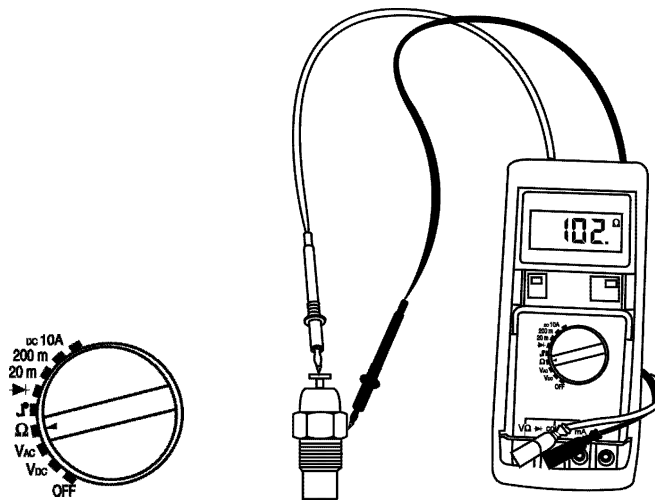

	At 20°C	At 90°C
50cc coolant type engine temperature sensor ref:736678	2.25 KΩ ±15%	108 Ω ±15%
125cc engine temperature sensor ref: 740358	1.10 KΩ ±15%	102 Ω ±15%

Choke heat expandable tip	5 Ω at 20°
Horn	2.5 to 5 Ω